

/

Tailor-made Air Ducting&Diffusers

Number of pieces : 1

Shape Circular, Number of diameters 2, Size 630-500 mm, Total length 98819 mm (76000+500+22319), First end Hem, Second end Blanking, 15pcs Zip 630, 4pcs Zip 500, Airflow 11970 m³/h (420+0), Available pressure 100 Pa, Number of airflow outlets 7, 7 Adapter Circular 315, Zip, Altitude 214 m

Fabric NMS - 100% polyester, Endless fibres (multifilament), Weight 225 g/m², Thickness 0,31 mm, Permeability 0 m³/h/m² by 120 Pa, strength (warp/weft) 1810/1090 N (EN ISO 13934-1:1999), Fire resistance - B-s1, d0 according to EN 13501-1+A1: 2010, Temperature resistance -30 a +110°C, Washing shrinkage (warp/weft) 0,5/0,5 % by 40°C according to EN ISO 6330-2000, Suitable for cleanrooms - class No. 4 (EN ISO 14644-1), Washable in washing-machine, Colour Red



List of mounting material:

1pcs 207638 mm Plastic-coated galvanized wire, 8pcs Galvanized lock nut , 12pcs Galvanized turn buckle , 40pcs Plastic-coated wire hangers 1500 mm, 398pcs Plastic hooks 347/353 mm, 1pcs Circular 630 mm Stainless steel strip

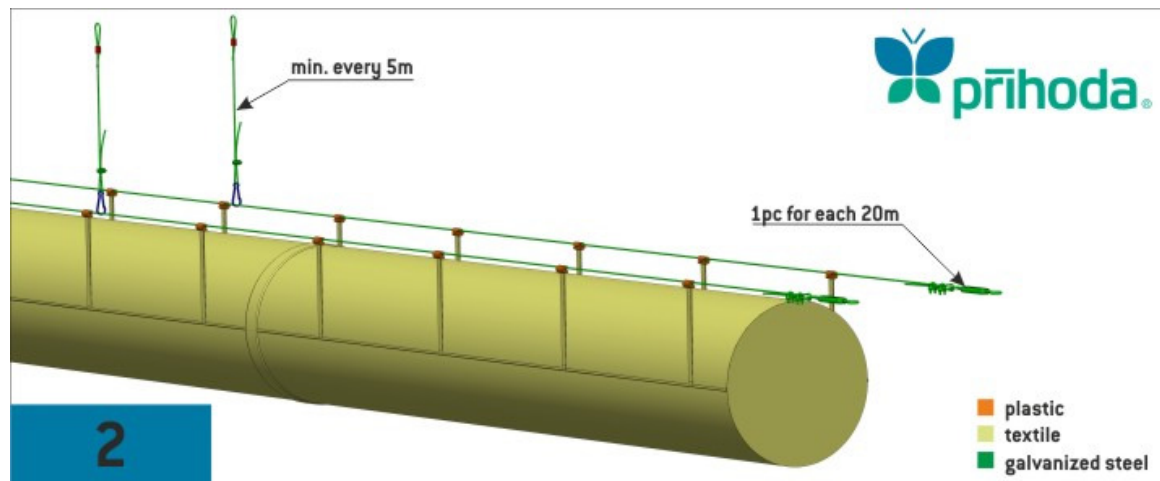
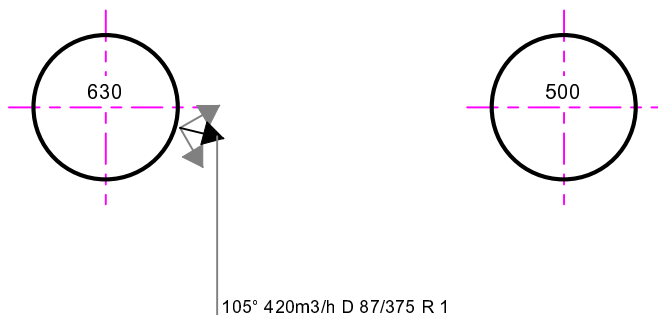

Price for 1 pc : 0,00

Total price for pos. 1 : 0,00

Weight : 57 kg

Order number Felix

Position: 2 / 4



/
Tailor-made Air Ducting&Diffusers

Number of pieces : 7

Shape Circular, Size 315 mm, Total length 18000 mm, First end Zip, Second end Blanking, 4pcs Zip 315, Airflow 1650 m3/h, Available pressure 70 Pa, Altitude 214 m

Fabric NMS - 100% polyester, Endless fibres (multifilament), Weight 225 g/m², Thickness 0,31 mm, Permeability 0 m³/h/m² by 120 Pa, strength (warp/weft) 1810/1090 N (EN ISO 13934-1:1999), Fire resistance - B-s1, d0 according to EN 13501-1+A1: 2010, Temperature resistance -30 a +110°C, Washing shrinkage (warp/weft) 0,5/0,5 % by 40°C according to EN ISO 6330-2000, Suitable for cleanrooms - class No. 4 (EN ISO 14644-1), Washable in washing-machine, Colour Red



List of mounting material:
1pcs 23000 mm Plastic-coated galvanized wire, 4pcs Galvanized lock nut , 2pcs Galvanized turn buckle , 4pcs Plastic-coated wire hangers 1500 mm, 37pcs Snap hook 189 mm

Microperforation

S1 A 16200mm, 1650m3/h, Direction/Area 180/120

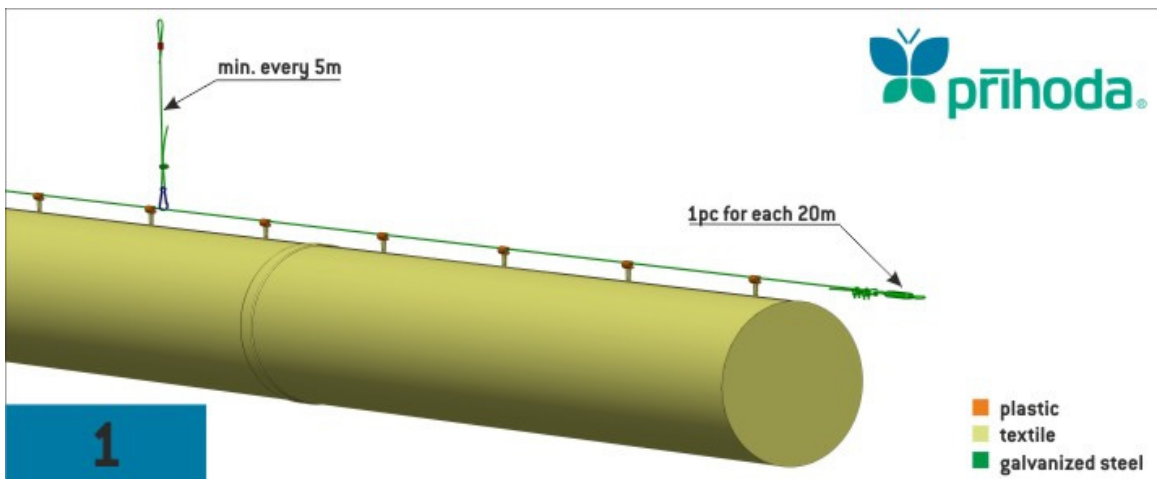
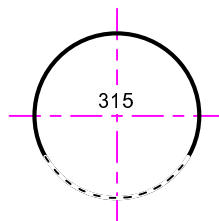

1

Price for 1 pc : 0,00

Total price for pos. 2 : 0,00

Weight : 38 kg

Order number Felix

Position: 3 / 4



/

Tailor-made Air Ducting&Diffusers

Number of pieces : 1

Shape Circular, Number of diameters 2, Size 630-500 mm, Total length 58700 mm (29950+500+28250), First end Hem, Second end Blanking, 5pcs Zip 630, 6pcs Zip 500, Airflow 10260 m3/h (0+0), Available pressure 100 Pa, Number of airflow outlets 6, 6 Adapter Circular 315, Zip, Altitude 214 m

Fabric NMS - 100% polyester, Endless fibres (multifilament), Weight 225 g/m², Thickness 0,31 mm, Permeability 0 m³/h/m² by 120 Pa, strength (warp/weft) 1810/1090 N (EN ISO 13934-1:1999), Fire resistance - B-s1, d0 according to EN 13501-1+A1: 2010, Temperature resistance -30 a +110°C, Washing shrinkage (warp/weft) 0,5/0,5 % by 40°C according to EN ISO 6330-2000, Suitable for cleanrooms - class No. 4 (EN ISO 14644-1), Washable in washing-machine, Colour Red



List of mounting material:

1pcs 127400 mm Plastic-coated galvanized wire, 8pcs Galvanized lock nut , 8pcs Galvanized turn buckle , 24pcs Plastic-coated wire hangers 1500 mm, 238pcs Plastic hooks 347/353 mm, 1pcs Circular 630 mm Stainless steel strip

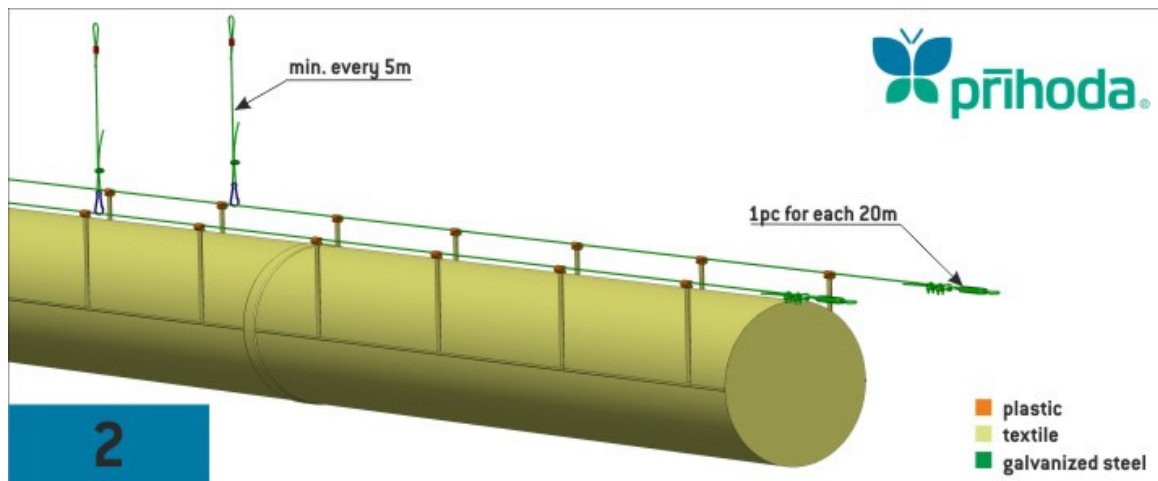
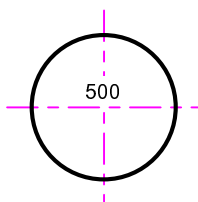
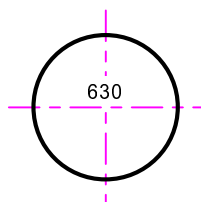

2

Price for 1 pc : 0,00

Total price for pos. 3 : 0,00

Weight : 33 kg

Order number Felix

Position: 4 / 4



/ **Tailor-made Air Ducting&Diffusers**

Number of pieces : 6

Shape Circular, Size 315 mm, Total length 16000 mm, First end Zip, Second end Blanking, 3pcs Zip 315, Airflow 1710 m3/h, Available pressure 77 Pa, Altitude 214 m

Fabric NMS - 100% polyester, Endless fibres (multifilament), Weight 225 g/m², Thickness 0,31 mm, Permeability 0 m³/h/m² by 120 Pa, strength (warp/weft) 1810/1090 N (EN ISO 13934-1:1999), Fire resistance - B-s1, d0 according to EN 13501-1+A1: 2010, Temperature resistance -30 a +110°C, Washing shrinkage (warp/weft) 0,5/0,5 % by 40°C according to EN ISO 6330-2000, Suitable for cleanrooms - class No. 4 (EN ISO 14644-1), Washable in washing-machine, Colour Red



List of mounting material:
1pcs 21000 mm Plastic-coated galvanized wire, 4pcs Galvanized lock nut , 2pcs Galvanized turn buckle , 4pcs Plastic-coated wire hangers 1500 mm, 33pcs Plastic hooks 189 mm

Microperforation

S1 A 14400mm, 1710m3/h, Direction/Area 180/120

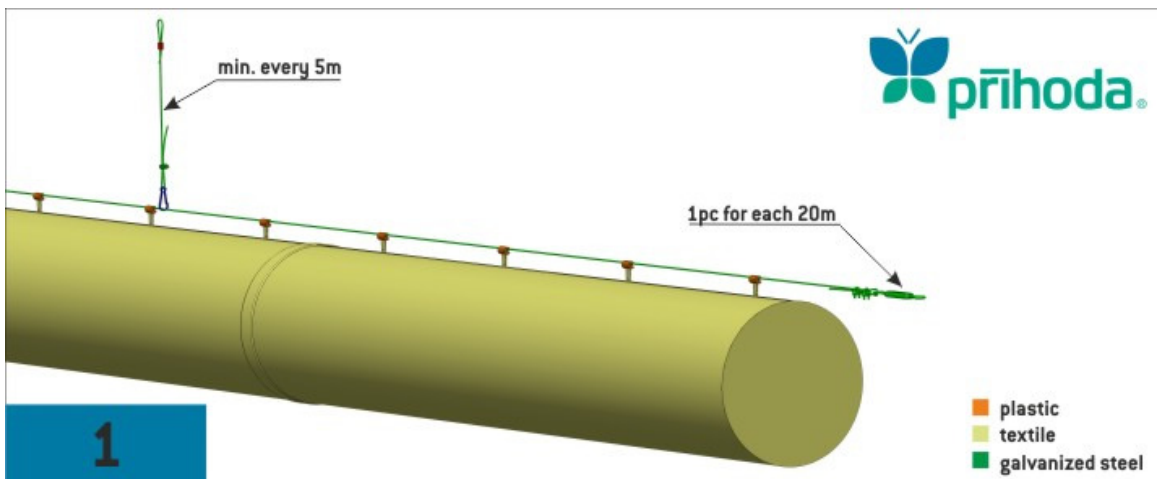
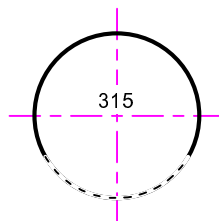

Price for 1 pc :	0,00	Total price for pos. 4 :	0,00
-------------------------	-------------	---------------------------------	-------------

Weight : 30 kg

/
Tailor-made Air Ducting&Diffusers

Position	pcs.-weight/profiles-price 1pc./all
1 - C630/98819 HB/NMS-2/RE + 7 OUT(7xC315Z)	1pcs 57 kg / 0 kg - 0,00 / 0,00
2 - C315/18000 ZB/NMS-1/RE	7pcs 37 kg / 0 kg - 0,00 / 0,00
3 - C630/58700 HB/NMS-2/RE + 6 OUT(6xC315Z)	1pcs 32 kg / 0 kg - 0,00 / 0,00
4 - C315/16000 ZB/NMS-1/RE	6pcs 29 kg / 0 kg - 0,00 / 0,00

Total price for pos. 1 - 4 :**0,00**

Weight : 156 kg

Position 1 - 1pcs ... 1 - C630/98819 HB/NMS-2/RE + 7 OUT(7xC315Z)

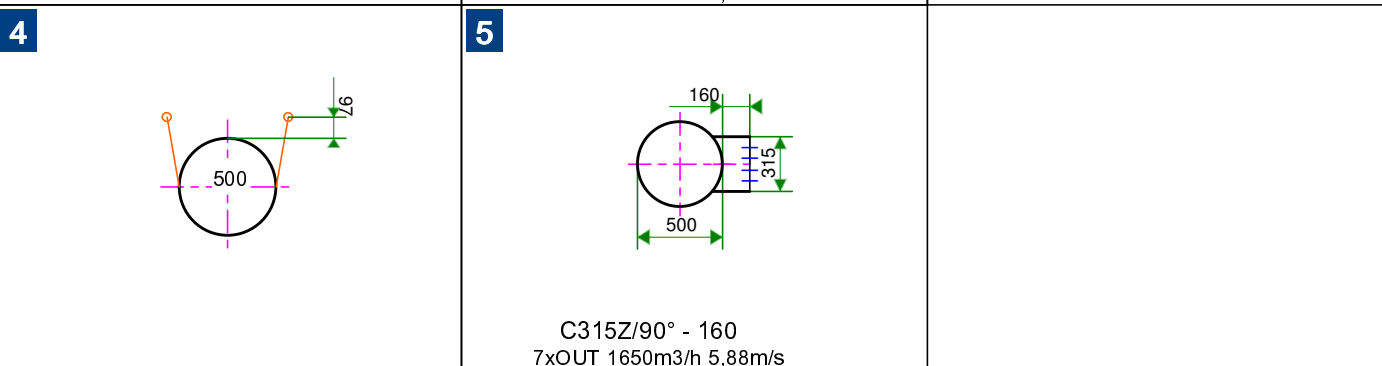
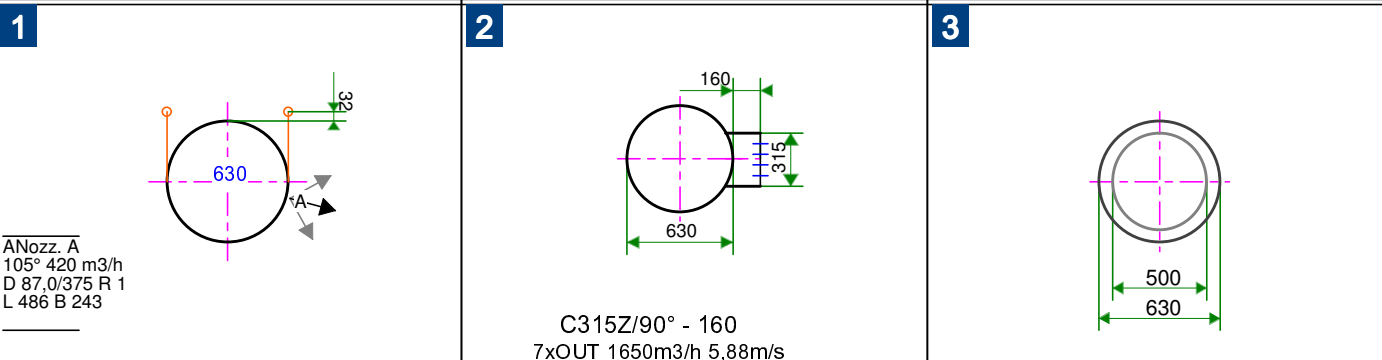
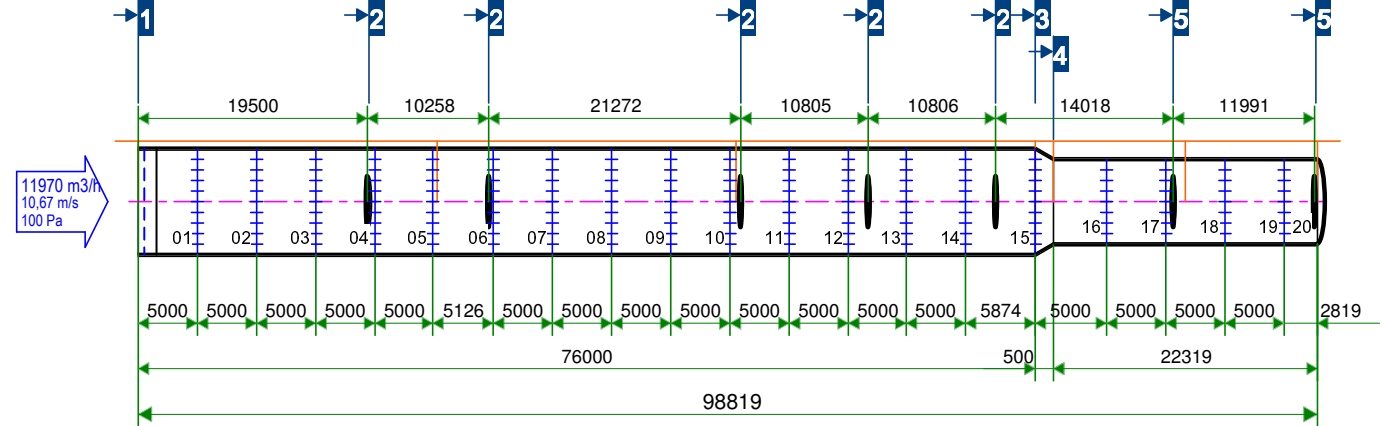

Position 2 - 7pcs ... 2 - C315/18000 ZB/NMS-1/RE
PVC CARABINE INSTEAD OF HOOKS

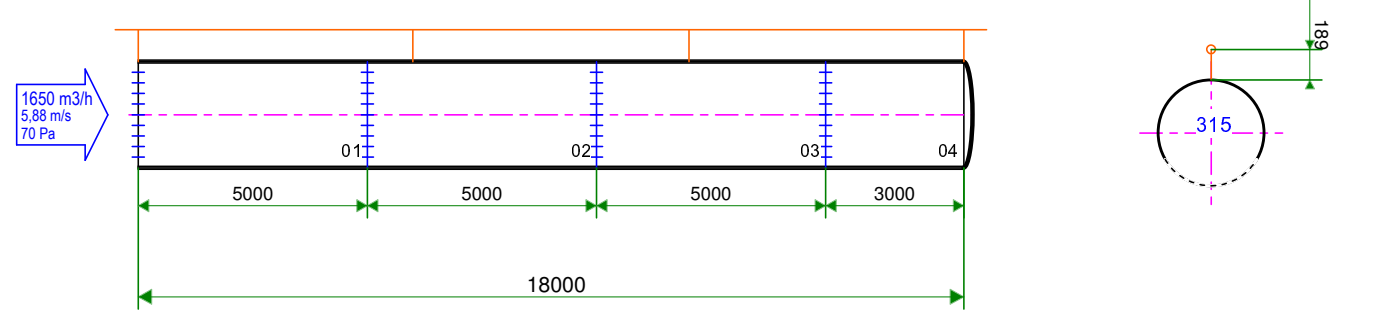

The numbers of parts from the drawing are printed on the labels at zips.

Dimensions in (mm)

DRAWING N.	VERSION	PAGE	DATE	DRAW	NO SCALE	 +3725236671
Č. VÝKRESU	VERZE	LIST	DATUM	KRESLIL	BEZ	
Felix	1	1/2	7.8.2020	Erki-Heiki Meerits	MĚŘITKA	

Position 3 - 1pcs ... 3 - C630/58700 HB/NMS-2/RE + 6 OUT(6xC315Z)

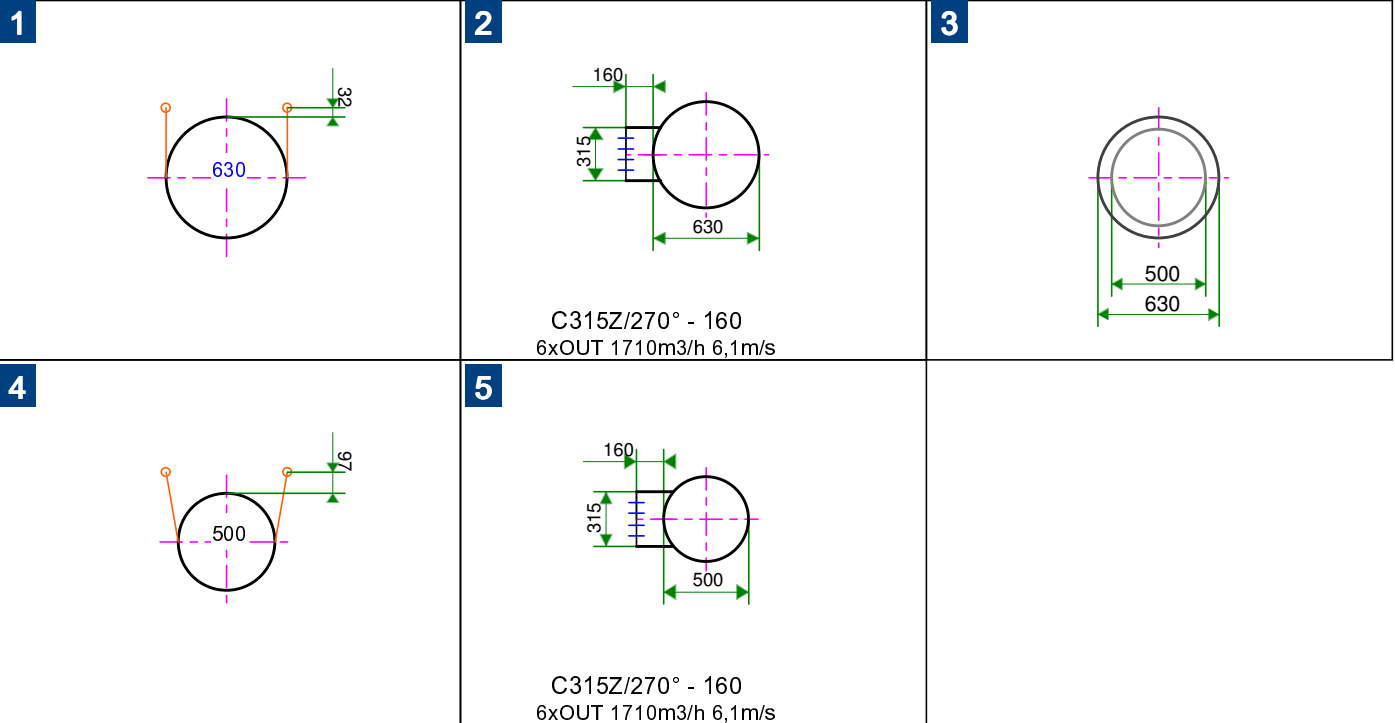
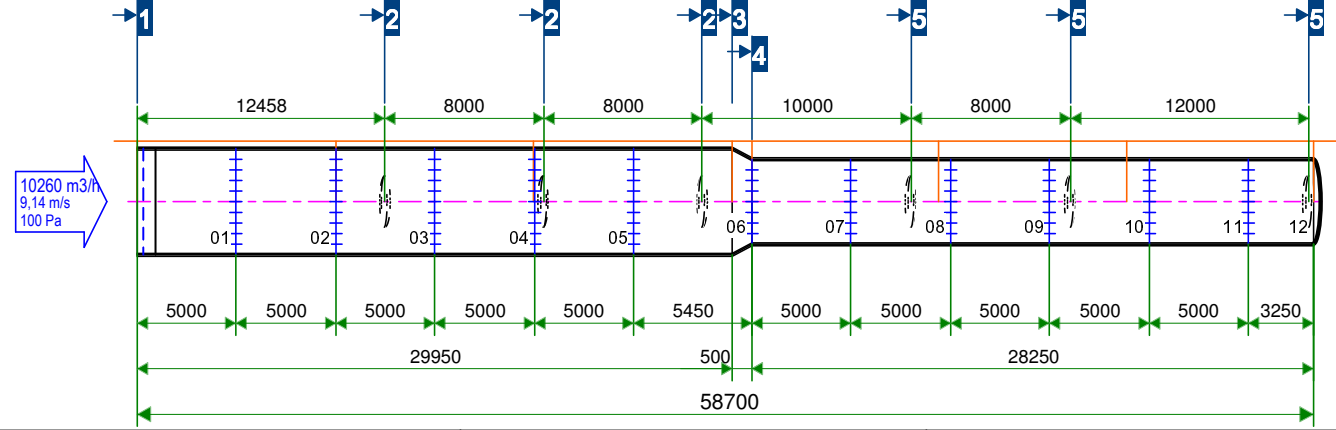

Position 4 - 6pcs ... 4 - C315/16000 ZB/NMS-1/RE

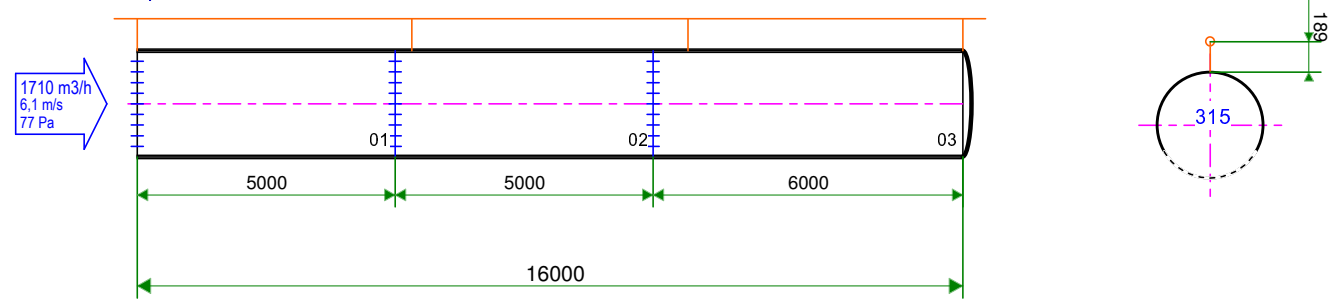

The numbers of parts from the drawing are printed on the labels at zips.

Dimensions in (mm)

DRAWING N.	VERSION	PAGE	DATE	DRAW	NO SCALE	 +3725236671
Č. VÝKRESU	VERZE	LIST	DATUM	KRESLIL	BEZ	
Felix	1	2/2	7.8.2020	Erki-Heiki Meerits	MĚŘITKA	

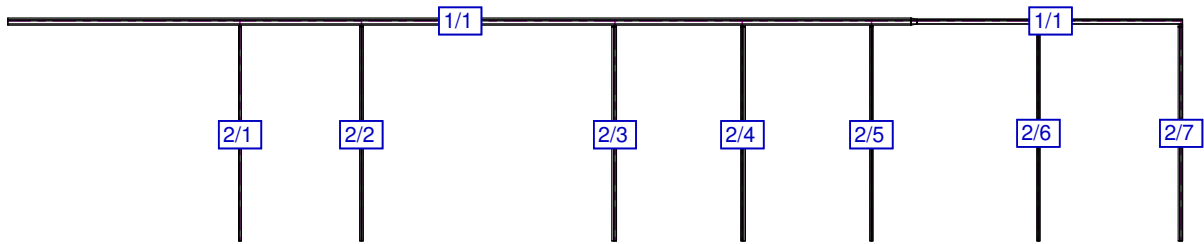

The view is from 0° angle (0° = Top view, 90° or 270° = Side view)

Color ■
Aspect ratio (Size : Length) 1 : 1

DRAWING N.	VERSION	SYSTEM	DATE	DRAW	NO SCALE	 +3725236671
Č. VÝKRESU	VERZE	SYSTÉM	DATUM	KRESLIL	BEZ	
Felix	1	1	7.8.2020	Erki-Heiki Meerits	MĚŘÍTKA	

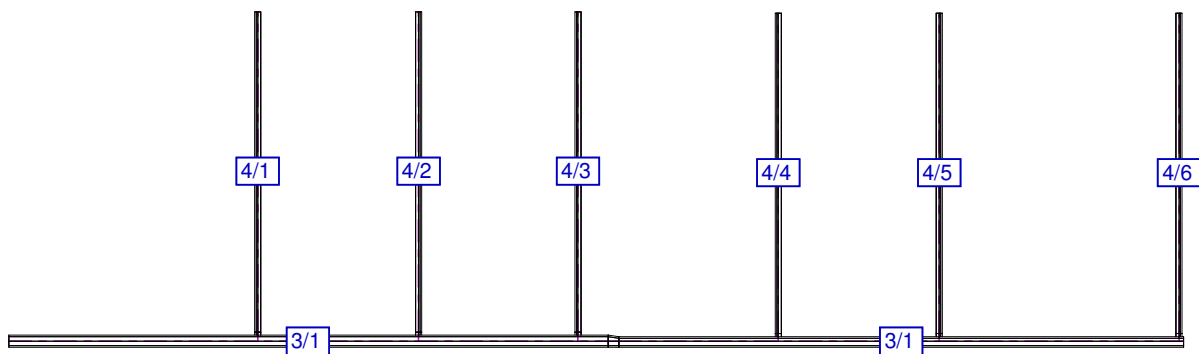

The view is from 0° angle (0° = Top view, 90° or 270° = Side view)

Color ■
Aspect ratio (Size : Length) 1 : 1

DRAWING N.	VERSION	SYSTEM	DATE	DRAW	NO SCALE	 +3725236671
Č. VÝKRESU	VERZE	SYSTÉM	DATUM	KRESLIL	BEZ	
Felix	1	2	7.8.2020	Erki-Heiki Meerits	MĚŘÍTKA	

Position 1 Section 1 Mode ventilation Temperature difference 0 ° C

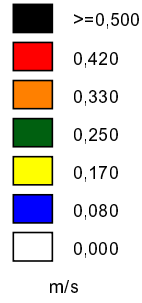
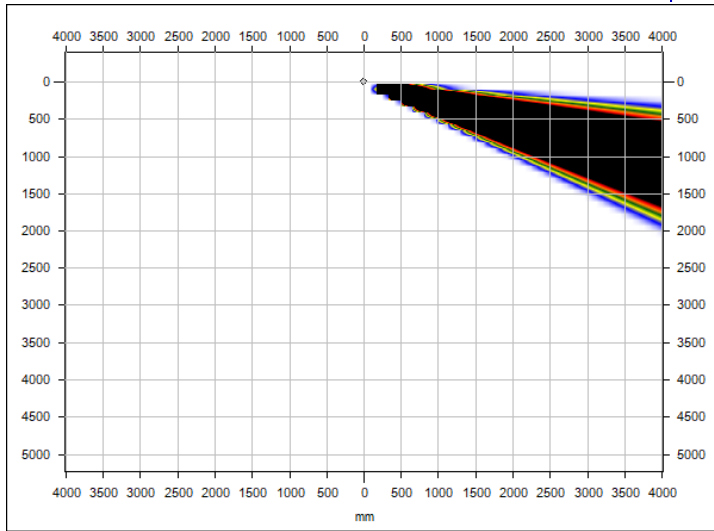

Position 2 Section 1 Mode ventilation Temperature difference 0 ° C

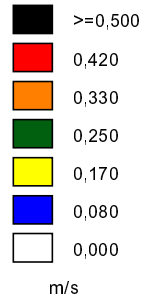
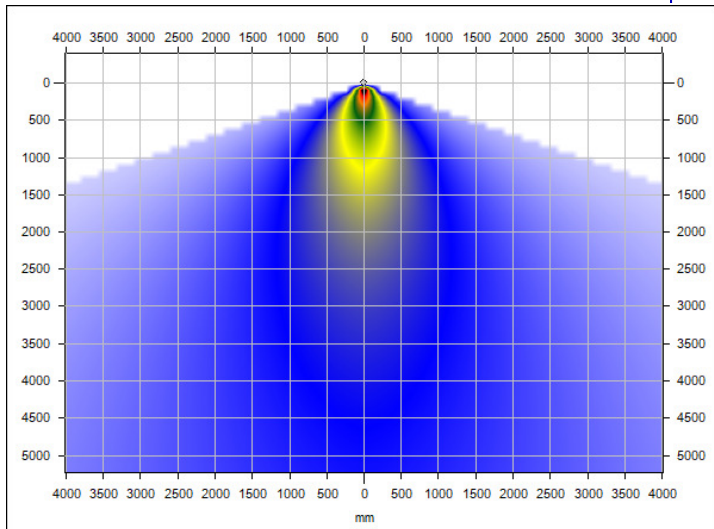

Position 4 Section 1 Mode ventilation Temperature difference 0 ° C

